

A pressure sensor, digital VAV controller and damper actuator all in one, providing a compact solution with a communications capability for pressure-independent VAV and CAV systems in the comfort zone

- Control modulating, communicative, hybrid
- Conversion of sensor signals
- Communication via BACnet MS/TP, Modbus RTU, Belimo MP-Bus or conventional control
- Service socket for operating devices

Product Features

Application	The digital VAV-Compact has PI control characteristics and is used for pressure-independent control of VAV units in the comfort zone.															
Pressure measurement	The integrated D3 differential pressure sensor is also suitable for very small volumetric flows. The maintenance-free sensor technology enables versatile applications in the comfort zone: in residential construction, offices, hospitals, hotels, cruise ships, etc.															
Actuator	2 different actuator variants (45 or 90 in-lb) are available for different VAV unit structures.															
Control function	Volumetric flow (VAV-CAV) or Open-Loop (for integration in an external VAV control loop).															
VAV – variable volumetric flow	Demand-dependent setting of volumetric flows $\dot{V}_{\min \max}$ on a modulating reference variable via Modbus, e.g. room temperature / CO2 controller, DDC or Bus system, for energy-saving air conditioning in individual rooms or zones.															
DCV – Demand Controlled Ventilation	In higher-level BACnet / Modbus system, for example with integrated optimiser function.															
Mode of operation	The actuator is fitted with an integrated interface for BACnet MS/TP, Modbus RTU and MP-Bus, it receives the digital positioning signal from the upper system and returns the current status.															
Converter for sensors	Connection option for a sensor (active or with switching contact). In this way, the analogue sensor signal can be easily digitised and transferred to the bus systems BACnet, Modbus or MP-Bus.															
Parameterization	The factory settings cover the most common applications. As desired, individual parameters can be adapted for specific systems or servicing with a service tool (e.g. ZTH US).															
Communication parameters	The communication parameters of the bus systems (address, baud rate, ...) are set with the ZTH US. Pressing push-button "Address" while connecting the supply voltage resets the communication parameters to the factory setting. Quick addressing: The BACnet and Modbus address can alternatively be set using the buttons on the actuator and selecting 1 to 16. The value selected is added to the «Basic address» parameter and results in the effective BACnet and Modbus address.															
Combination analog - communicative (hybrid mode)	With conventional control by means of an analogue positioning signal, BACnet or Modbus can be used for the communicative position feedback															
Operating and service devices	Service tool ZTH, PC-Tool service socket: locally pluggable or via PP connection.															
Electrical connection	The connection is made with the integrated connection cable.															
Type overview	<table border="1" style="width: 100%; border-collapse: collapse;"> <thead> <tr> <th style="text-align: left;">Type</th> <th style="text-align: center;">Torque</th> <th style="text-align: center;">Power consumption</th> <th style="text-align: center;">Rating</th> <th style="text-align: center;">Weight</th> </tr> </thead> <tbody> <tr> <td>LMV-D3-MOD</td> <td style="text-align: center;">45 in-lb [5 Nm]</td> <td style="text-align: center;">2 W</td> <td style="text-align: center;">4 VA</td> <td style="text-align: center;">Approx. 1.1 lb [500 g]</td> </tr> <tr> <td>NMV-D3-MOD</td> <td style="text-align: center;">90 in-lb [10 Nm]</td> <td style="text-align: center;">3 W</td> <td style="text-align: center;">5 VA</td> <td style="text-align: center;">Approx. 1.5 lb [700 g]</td> </tr> </tbody> </table>	Type	Torque	Power consumption	Rating	Weight	LMV-D3-MOD	45 in-lb [5 Nm]	2 W	4 VA	Approx. 1.1 lb [500 g]	NMV-D3-MOD	90 in-lb [10 Nm]	3 W	5 VA	Approx. 1.5 lb [700 g]
Type	Torque	Power consumption	Rating	Weight												
LMV-D3-MOD	45 in-lb [5 Nm]	2 W	4 VA	Approx. 1.1 lb [500 g]												
NMV-D3-MOD	90 in-lb [10 Nm]	3 W	5 VA	Approx. 1.5 lb [700 g]												
Other versions	The VAV-Compact is also available with a built-in interface for direct integration in MP-Bus systems. MFT and MP versions also available. See www.belimo.us for more information and documentation.															

Safety notes



- The device must not be used outside the specified field of application, especially not in aircraft or in any other airborne means of transport.
- Outdoor applications: possible only in the absence of direct effects on the actuator from (sea) water, snow, ice, sunlight and aggressive gases and when it is guaranteed that the ambient conditions do not deviate at any time from the limit values specified in the datasheet.
- Only authorized specialists may carry out installation. All applicable legal or institutional installation regulations must be complied with during installation.
- The device may only be opened at the manufacturer's site. It does not contain any parts that can be replaced or repaired by the user.
- Cables must not be removed from the device.
- When calculating the torque required, the specifications supplied by the damper manufacturers (cross-section, construction, place of installation), and the ventilation conditions must be observed.
- The device contains electrical and electronic components and is not allowed to be disposed of as household refuse. All locally valid regulations and requirements must be observed.

Electrical installation

Notes

- Supply via safety isolating transformer!
- Modbus signal assignment:
C = D- = A
C = D+ = B
- Supply and communication are not galvanically isolated.
- Connect earth signal for devices with one another.

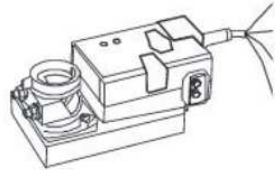

No.	Designation	Wire color	Function
	-	black	} AC/DC 24 V supply
		red	
	▶ MFT	orange	MP connection
	D-	pink	} BACnet / Modbus (RS485)
	D+	grey	

See separate documentation for description of functions and applications

Technical Data

Electrical data	Nominal voltage	AC/DC 24 V, 50/60 Hz
	Operating range	AC 19.2...28.8V / DC 21.6...28.8V
	Performance data	See Overview of types (page 1)
	Connection	3 ft [1 m] 18 GA plenum rated cable, [6 x .75 mm], preassembled
Volumetric flow controllers	Control function	VAV/CAV and Open-Loop
	$\dot{V}_{nom}^{1)}$	Application specific nominal volumetric flow setting, dependent upon VAV box parameters. Used for calibration.
	$\Delta p @ \dot{V}_{nom}^{1)}$	Change in pressure at nominal volumetric flow setting, dependent upon VAV box parameters. Used for calibration
	\dot{V}_{max}	20...100 % of \dot{V}_{nom} , adjustable
	\dot{V}_{mid}	$\dot{V}_{min} \dots < \dot{V}_{max}$, adjustable
	\dot{V}_{min}	0...100 % of \dot{V}_{nom} , adjustable ($< \dot{V}_{max}$)
Sensor integration	input	0...32 V, input impedance 100 k
	Sensor	Active Sensor (0...10 V) Switching contact (0 / 1) switching capacity 16 mA @ 24 V
Local override control	Override	CLOSED / \dot{V}_{max} / OPEN, AC 24 V supply required
Communicative control	BACnet MS/TP	
	Modbus RTU	(ex works)
	MP-Bus	
Operation and service	Service tool ZTH, PC-Tool	Local plug / Remote via PP connection
	LED	Supply , status and communication display
	Push-button	Addressing, angle of rotation adaptation and test function
Actuator	Rotary/linear version	Brushless, non-blocking actuator with power-save mode
	Direction of rotation	ccw / cw
	Angle of rotation	95°, adjustable mechanical or electronic limiting
	Gear disengagement	Push-button self-resetting without functional impairment
	Position indication	Mechanical or accessible (Tool, Bus-Master)
	Spindle holder	Spindle clamp for round and square shafts
Volumetric flow measurement	Differential pressure sensor	Belimo D3 sensor, dynamic measurement principle
	Measurement range, operating range	-0.08...2 in WC [-20...500 Pa], 0...2 in WC [0...500 Pa]
	Overload capability	± 12 in WC [± 3000 Pa]
	Altitude compensation	Adaptation to system altitude (adjustable between 0...9800 ft [0...3000 m] above sea level)
	Installation position	Any, no reset necessary
	Materials in contact with medium	Glass, epoxy resin, PA, TPE
	Measuring air conditions	Comfort zone 32...122°F [0...50°C] / 5...95% rH, non-condensing
Safety	Protection class IEC/EN	III Safety extra-low voltage
	Degree of protection IEC / EN	IP54
	EMC	CE according to 2014/30/EU
	Certification IEC/EN	IEC/EN 60730-1 and IEC/EN 60730-2-14
	Rated current voltage	0.8 kV
	Supply / control	
	Control pollution degree	
	Ambient temperature	-22...+122°F [-30...50°C]
	Non-operating temperature	-40...+176°F [-40...80°C]
	Ambient humidity range	95% r.h., non-condensing
Maintenance	Maintenance-free. Depending on the application, the differential pressure sensor (measuring cross, disc, ...) of the VAV unit is checked occasionally and cleaned if required.	
UL listing	cULus according to UL 60730-1A/-2-14, UL 2043	

1) Set during calibration. Dependent upon VAV box parameters

Electrical installation



- Notes**
- Connection via safety isolating transformer.
 - The wiring of the line for Modbus (RTU) / BACnet (MS/TP) is to be carried out in accordance with applicable RS485 regulations.
 - Modbus / BACnet: Supply and communication are not galvanically isolated. Connect earth signal of the devices with one another.

BACnet MS/TP / Modbus RTU

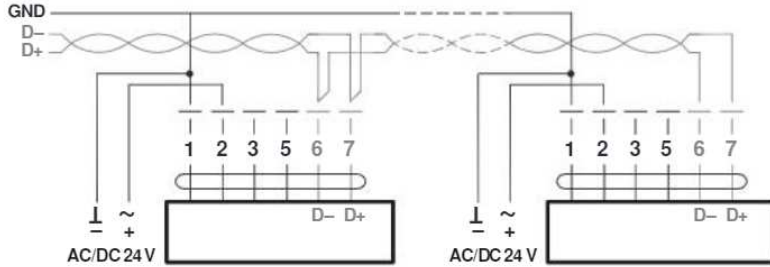

Cable colors:

- 1 = black
- 2 = red
- 3 = white
- 5 = orange
- 6 = pink
- 7 = gray

Signal assignment Modbus:

- = D- = A
- = D+ = B

Connection with switching contact, e.g. Δp -monitor

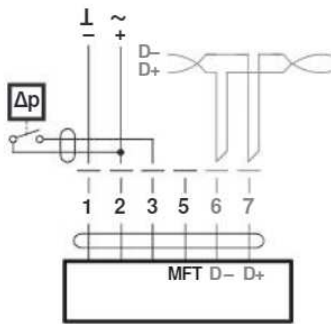

Switching contact requirements:
The switching contact must be able to switch a current of 16 mA at 24 V accurately.

Connection of active sensors, e.g. 0...10 V @ 0...100°F [0...50°C]

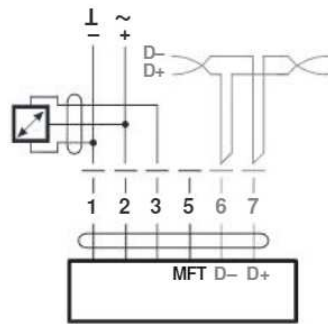

Possible voltage range:
0...32 V (resolution 30 mV)

BACnet MS/TP / Modbus RTU with analog setpoint (hybrid mode)

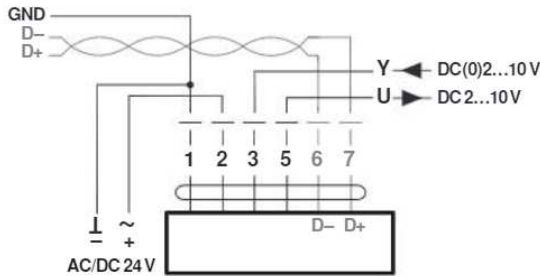

Operating on the MP-Bus

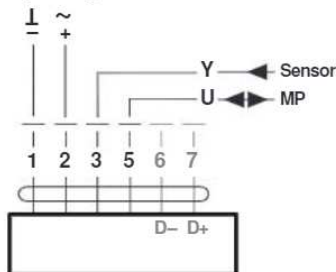

Electrical installation

Local override control

If no sensor is integrated, then connection 3 (Y) is available for the protective circuit of a local override control.

Options: CLOSED – \dot{V}_{max} – OPEN

Note: Functions only with AC 24 V supply!

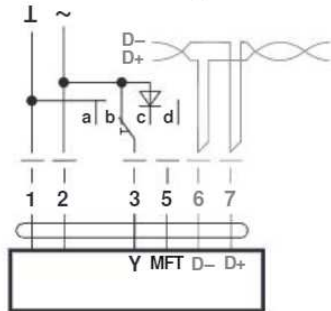

Damper CLOSED
 \dot{V}_{max}
Damper OPEN
Bus mode

Control functions - VAV

VAV-operating volumetric flow – Setting and control

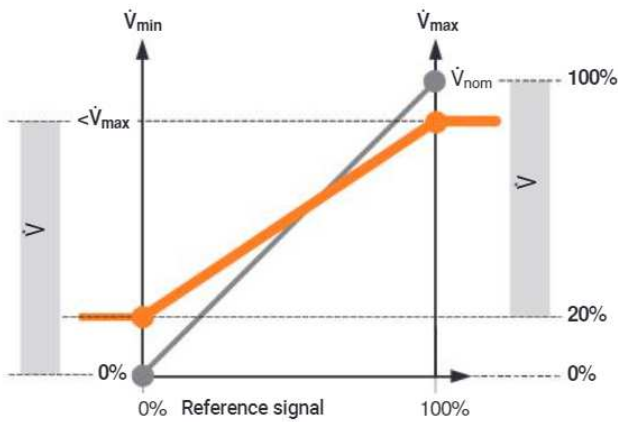

Open-Loop (separate external VAV-Control)

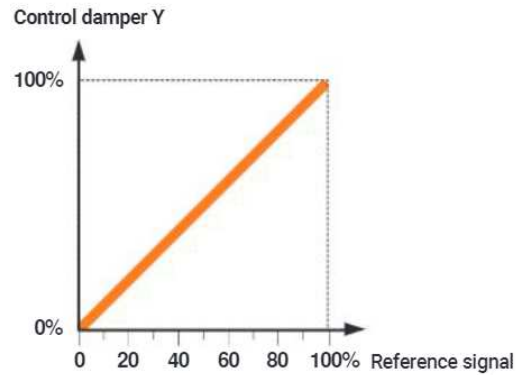

VAV-operating volumetric flow - Example

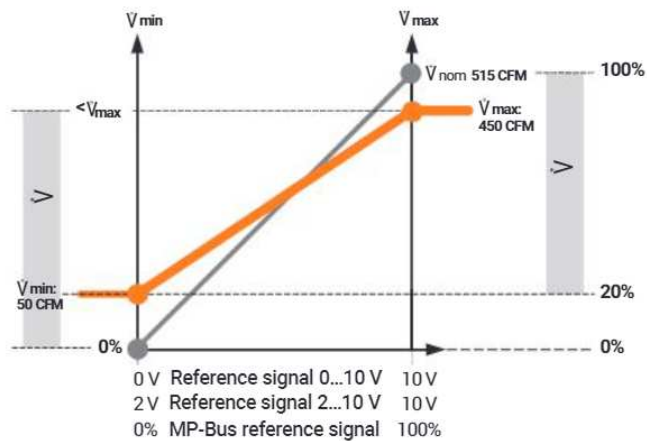

\dot{V}_{nom} - Volumetric flow rate used for calibration

\dot{V}_{max} - Max desired volumetric flow rate

\dot{V}_{min} - Minimum desired volumetric flow rate

Setting and Tool function

Designation	Adjustment values, limits, explanations	Units	Tools ⁵⁾		Remarks
			ZTH US	PC-Tool	
System specific data					
Position	16 characters e.g.: Office 4 6.0G ZL	Text	r	r/w	
Designation	16 Characters: Unit designation, etc.	Text	r	r/w	
Modbus address	1...247		r/w		Modbus addressing
Address (MP)	Baud rate and etc. PP		r/w	r/w	for Modbus applications: PP
\dot{V}_{max}	20...100 % [\dot{V}_{nom}]	/h / l/s / cfm	r/w	r/w	>/= \dot{V}_{min}
\dot{V}_{mid}	\dot{V}_{min} ... \dot{V}_{max}	/h / l/s / cfm	r/w	r/w	
\dot{V}_{min}	0...100 % [\dot{V}_{nom}]	/h / l/s / cfm	r/w	r/w	</= \dot{V}_{max}
System altitude	0...9800 [0...3000]	Feet [Meter]	r/w	r/w	Adaptation of Δp -Sensor to system altitude (above sea level)
Controller settings					
Controller function	Volumetric flow / open loop			r/w	
Mode	0...10 / 2...10	Volt		r/w	for Modbus applications: 2...10
CAV function ²⁾	CLOSED/ \dot{V}_{min} / \dot{V}_{max} ; Shut-off level CLOSED 0.1 V CLOSED/ \dot{V}_{min} / \dot{V}_{max} ; Shut-off level CLOSED 0.5 V		-	r/w	not relevant for Modbus applications
Positioning signal Y	Start value: 0.6...30; Stop value: 2.6...32	Volt	r	r/w	not relevant for Modbus applications
Feedback U	Volume / damper position / Δp		-	r/w	not relevant for Modbus applications
Feedback U	Start value: 0.0...8.0; Stop value: 2.0...10	Volt	-	r/w	not relevant for Modbus applications
Response when switched on (Power-On) ⁴⁾	No action / Adaption / Synchronization			r/w	
Synchronization behavior	Y=0 % Y=100 %			r/w	Synchronization to damper position 0 or 100 %
Bus fail position	Last set point / Damper CLOSED \dot{V}_{min} / \dot{V}_{max} / Damper OPEN			r/w	
Unit specific settings ³⁾ Write function only available for VAV manufacturer					
\dot{V}_{nom}	0...35,000 CFM [0...60,000 m ³ /h]	/h / l/s / cfm	r	r/(w*)	Unit specific adjustment value
$\Delta p@ \dot{V}_{nom}$	0.15...2 in WC [38...500 Pa]	in WC [Pa]	r	r/(w*)	Unit specific adjustment value
Label print function			-	w	Incl. customer logo
Other settings					
Direction of rotation (for Y = 100%)	cw/ccw		r/w ¹⁾	r/w	
Range of rotation	Adapted ³⁾ / programmed 30...95			r/w	
Torque	100 / 75 / 50 / 25			r/w	% of nominal torque
Operating data					
Setpoint / actual value		/h / l/s / cfm	r	r	Trend display with print function and data storage on HD
Damper position		Pa / %			
Simulation	Damper CLOSED / OPEN \dot{V}_{min} / \dot{V}_{max} / motor stop				
Running times	Operating time, running time Ratio			r	
Alarm messages	Setting range enlarged, mech. overload, Stop&Go ratio too high			r/w	
Series number	Device ID.		r	r	incl. date of manufacture
Type	Type designation		r	r	
Version display	Firmware, Config table ID		r	r	
Configuration data					
Print, create PDF				Yes	
Save to file				Yes	
Log data / book	Activity log			Yes	incl. complete setting data

Explanations

1) Access only on operating level 2

2) CAV setting for MP/MF type

3) Within the mechanical limit.

4) The first time the supply voltage is switched on, i.e. at the time of commissioning, the actuator carries out an adaption, which is when the operating range and position feedback adjust themselves to the mechanical setting range. The actuator then moves into the required position in order to ensure the volumetric flow defined by the positioning signal.

5) See www.belimo.us for function and version history.

Display and operation

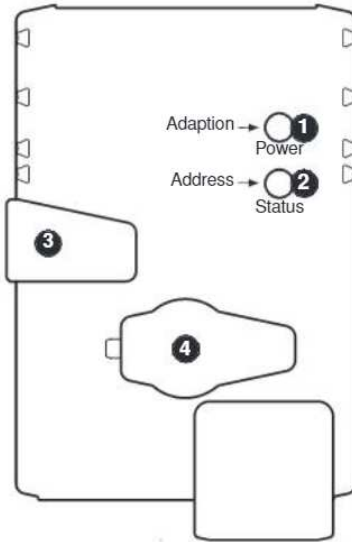

- 1 Push-button and LED display green**
 Off: No power supply or malfunction
 On: In operation
 Flashing: In address mode: Pulses according to set address (1...16)
 When starting: Reset to factory setting (Communication)
 Press button: In standard mode: Triggers angle of rotation adaptation
 In address mode: Confirmation of set address (1...16)
- 2 Push-button and LED display yellow**
 Off: Standard mode
 On: Adaption or synchronizing process active
 or actuator in address mode (LED display green flashing)
 Flickering: BACnet / Modbus communication active
 Press button: In operation (>3 s): Switch address mode on and off
 In address mode: Address setting by pressing several times
 When starting (>5 s): Reset to factory setting (Communication)
- 3 Gear disengagement button**
 Press button: Gear disengaged, motor stops, manual override possible
 Release button: Gear engaged, synchronization starts, followed by standard mode
- 4 Service plug**
 For connecting parameterization and service tools

Check power supply connection

- 1** Off and **2** On Possible wiring error in power supply

Quick addressing

1. Press the "Address" button until the green "Power" LED display is no longer illuminated. The green "Adaption" LED display flashes in accordance with the previously set address.
 2. Set the address by pressing the "Address" button the corresponding number of times (1-16).
 3. The green LED flashes in accordance with address that has been entered (1-16).
 If the address is not correct, then this can be reset in accordance with Step 2.
 4. Confirm the address setting by pressing the green "Adaption" button.
- If no confirmation occurs for 60 seconds, then the address procedure is ended.
 Any address change that has been made will be discarded.
 The resulting BACnet MS/TP and Modbus RTU address is made up of the set basic address plus the short address (e.g. 100+7=107).

ZTH / PC-Tool - local service connection

The settings and diagnostics of the VAV-Compact can be performed easily and rapidly with the Belimo PC-Tool or with the ZTH US service tool. When using the PC-Tool, the ZTH US serves as an interface converter.

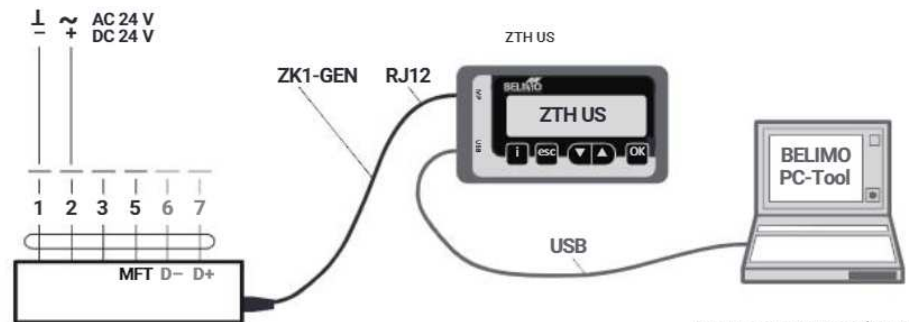

Download PC-Tool (MFT-P)
from www.belimo.us

Display and operation

ZTH / PC-Tool - remote connection The VAV-Compact can communicate with the service tools via the PP connection (wire 5). The connection can be made in operating mode in the junction box or the control cabinet terminals. When using the PC-Tool, the ZTH US serves as an interface converter.

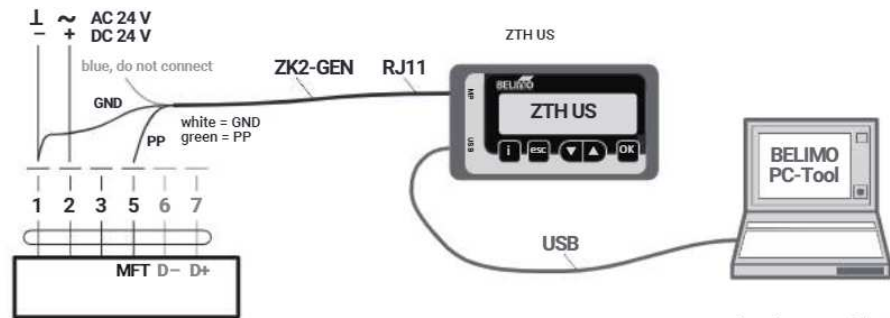

Download PC-Tool (MFT-P)
from www.belimo.us

Accessories

VAV-Compact	Description
	VAV-Compact: version with integrated MP-Bus see www.belimo.us for more information and documentation

Electrical accessories	Description	Type
	Connection cable 16 ft [5 m], to ZTH (RJ12) with service plug	ZK1-GEN
	Connection cable 16 ft [5 m], to ZTH (RJ11) with free wire ends	ZK2-GEN

Tools	Description	Type
	Service tool for parametrizable and communicative Belimo actuators / VAV controller and HVAC performance devices	ZTH US
	Belimo PC-Tool, software for adjustments and diagnostics (Free download available at www.belimo.us)	
	Adapter to Service Tool ZTH	MFT-C

Dimensions [mm]

Dimensional drawings LMV-D3-MOD

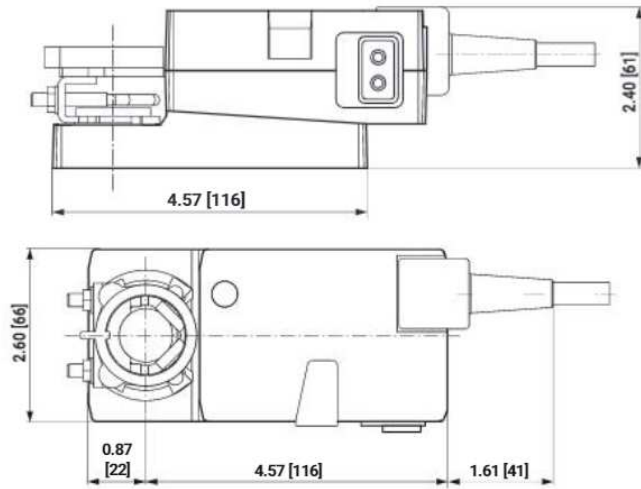

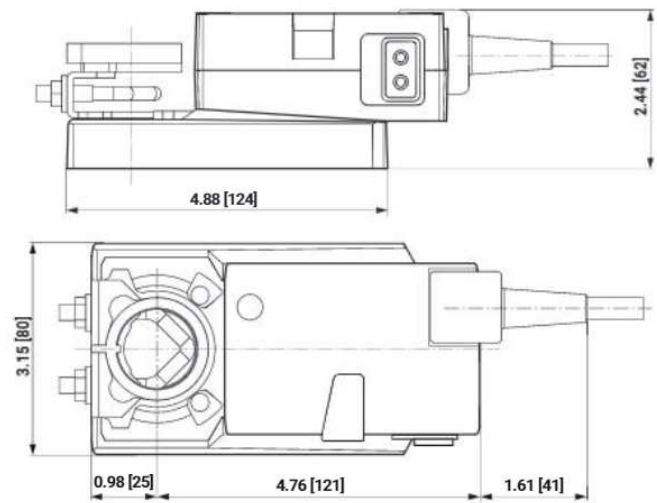

Dimensional drawings NMV-D3-MOD



Further documentation

- Tool connections
- BACnet Protocol Implementation Conformance Statement PICS
- Description Modbus-Register
- Overview MP Cooperation Partners
- MP Glossary
- Introduction to MP-Bus-Technology

	-MFT	-MP	-MOD
			
Field of application: Supply and exhaust air in the comfort zone and sensor-compatible media			
AC/DC 24 V supply			
Integrated Δp sensor, dynamic D3, measuring range:	-0.08 ... 2 in WC [-20...500 Pa]	-0.08 ... 2 in WC [-20...500 Pa]	-0.08 ... 2 in WC [-20...500 Pa]
Actuator variants: – Rotary actuator – Linear actuator	45/90 in-lb [5/10 Nm]	45/90 in-lb [5/10 Nm] 100/200/300 mm	45/90 in-lb [5/10 Nm]
VAV function \dot{V}_{\min} ... \dot{V}_{\max}			
CAV stages \dot{V}_{\min} / \dot{V}_{mid} / \dot{V}_{\max}			
Open Loop (external V control)			
DCV	Yes*	DDC MP Partners*	Yes*
Analog control	0/2...10 V	0/2...10 V	0/2...10 V
With bus control			
Bus specification		Belimo MP bus	Modbus RTU / BACnet MS/TP / RS485
Direct integration DDC MP Partners			
Integration via Gateway – BACnet – KNX – LONWORKS® – Modbus RTU			
Number of bus devices		8 per strand	32 per strand
Sensor integration – passive (resistance) – active (0...10 V) – Switching contact			
Optional control function			
Local forced (override)		CLOSED / \dot{V}_{\max} / OPEN	CLOSED / \dot{V}_{\max} / OPEN
Aids		MP-Bus Tester MP Monitor	
Integration tools		PC-Tool	
TypeList function (Retrofit, OEM)			(-)
Tool connection (U – PP/MP)	PP	PP/MP	PP
Service socket ZTH / PC-Tool			
NFC interface			
Assistant App			
Service tool ZTH US			
PC-Tool – Parameter – Save data – Trend, Logbook – Label Print			

* Third party controller or control logic within BMS required.

