

A pressure sensor, digital VAV controller and damper actuator all in one, providing a compact solution with a communications capability for pressure-independent VAV and CAV systems in the comfort zone

- Control (0)2...10 V
- Gateway: BACnet / LON / Modbus / KNX
- DCV – Fan Optimizer function: DDC
- Conversion of sensor signals
- Service socket for operating devices



LMV-D3-MFT



NMV-D3-MFT

Product Features

Application	The VAV-Compact has PI control characteristics and is used for pressure-independent control of VAV units in the comfort zone.
Pressure measurement	The integrated D3 differential pressure sensor is also suitable for very small volumetric flows. The maintenance-free sensor technology enables versatile applications in the comfort zone: in residential construction, offices, hospitals, hotels, cruise ships, etc..
Actuator	VAV unit manufacturers offer different actuator variants (rotary or linear actuator) for different VAV units structures.
Control function	Volumetric flow (VAV-CAV) or Open-Loop (for integration in an external VAV control loop).
VAV – variable volumetric flow	Demand-dependent setting of volumetric flows \dot{V}_{\min} / \dot{V}_{\max} on a modulating reference variable (0/2...10 V), e.g. room temperature / CO2 controller, DDC or Bus system, for energy-saving air conditioning in individual rooms or zones.
CAV – constant volumetric flow	Step mode (via switching contact) for constant volume applications CLOSED / \dot{V}_{\min} / \dot{V}_{\max} / OPEN.
DCV – Demand Controlled Ventilation	With DDC with integrated DCV logic
Operating and service devices	Service tool ZTH, PC-Tool service socket: locally pluggable
Electrical connection	The connection is made with the integrated connection cable.

**Type overview
MFT versions**

Type	Torque	Power consumption	Rating	Weight
LMV-D3-MFT	45 in-lb [5 Nm]	2 W	3.5 VA	Approx. 1.1 lb [500 g]
NMV-D3-MFT	90 in-lb [10 Nm]	3 W	5 VA	Approx. 1.5 lb [700 g]

- OEM version** In addition to the standard Belimo version, there are OEM VAV-Compact versions available for VAV unit manufacturers' variants. These versions are customized and labelled specifically for OEM on the sensors, damper spindles and fastening systems used. See documentation of the VAV unit manufacturer.
Designation, e.g.: LMV-D3-MFT ABC (ABC = Customer designation)
- Other versions** The VAV-Compact is also available with a built-in interface for direct integration in BACnet and Modbus. MP version also available.
See www.belimo.us for more information and documentation.

Safety notes



- The device must not be used outside the specified field of application, especially not in aircraft or in any other airborne means of transport.
- Outdoor applications: possible only in the absence of direct effects on the actuator from (sea) water, snow, ice, sunlight and aggressive gases and when it is guaranteed that the ambient conditions do not deviate at any time from the limit values specified in the datasheet.
- Only authorized specialists may carry out installation. All applicable legal or institutional installation regulations must be complied with during installation.
- The device may only be opened at the manufacturer's site. It does not contain any parts that can be replaced or repaired by the user.
- Cables must not be removed from the device.
- When calculating the torque required, the specifications supplied by the damper manufacturers (cross-section, construction, place of installation), and the ventilation conditions must be observed.
- The device contains electrical and electronic components and is not allowed to be disposed of as household refuse. All locally valid regulations and requirements must be observed.

Electrical installation

Notes

- Supply via safety isolating transformer!
- In conventionally controlled systems it is recommended that the connections 1 to 5 (PP) are led to accessible terminals (e.g. floor distributor) in order to allow remote access for diagnostics and service work.

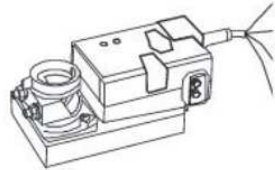

No.	Designation	Wire color	Function
	-	black	} AC/DC 24 V supply
		red	
	◀ Y	white	Reference signal / override / sensor
	▶	orange	- Actual value signal

See separate documentation for description of functions and applications

Technical Data

Electrical data	Nominal voltage	AC/DC 24 V, 50/60 Hz
	Operating range	AC 19.2 ... 28.8V / DC 21.6 ... 28.8V
	Performance data	See Overview of types (page 1)
	Connecting	3 ft [1 m] 18 GA plenum rated cable, [4 x 0.75 mm ²], preassembled
Volumetric flow controllers	Control function	VAV/CAV and Open-Loop
	\dot{V}_{nom} ¹⁾	Application specific nominal volumetric flow setting, dependent upon VAV box parameters. Used for calibration.
	$\Delta p @ \dot{V}_{nom}$ ¹⁾	Change in pressure at nominal volumetric flow setting, dependent upon VAV box parameters. Used for calibration.
	\dot{V}_{max}	20 ... 100 % of \dot{V}_{nom} , adjustable
	\dot{V}_{min}	0 ... 100 % of \dot{V}_{nom} , adjustable (< \dot{V}_{max})
Analogue control - VAV	Mode (Y)	0...10 V / 2...10 V / (Y and U5 individually) adjustable, input resistance 100 k (0/4 ... 20 mA with 500 resistance)
	Actual value signal (U)	0...10 V / 2...10 V, max. 0.5 mA Volumetric flow / damper position / Δp , selectable
Stepped control - CAV	Operating stages	CLOSED / \dot{V}_{min} / \dot{V}_{max} / OPEN
Bus mode	Control	The setpoint specification in % between the set \dot{V}_{min} / \dot{V}_{max} values
	Sensor integration	Passive sensor (PT1000, 10K2, ...) or active sensor (0...10 V) Switching contact (0 / 1) (switching capacity 16 mA @ 24 V)
Operation and servicing	Service tool ZTH, PC-Tool	Local plug
	LED	Supply, status and communication display
	Push-button	Addressing, angle of rotation adaptation and test function
Actuator	Rotary/linear version	Brushless, non-blocking actuator with power-save mode
	Direction of rotation	left / right or up / down, adjustable
	Angle of rotation	95° adjustable mechanical or electronic limiting
	Gear disengagement	Push-button self-resetting without functional impairment
	Position indication	Mechanical or accessible (Tool)
	Spindle holder	Spindle clamp for round and square shafts form fit, OEM versions
Volumetric flow measurement	Differential pressure sensor	Belimo D3 sensor, dynamic measurement principle
	Measurement range, operating range	-0.08...2 in WC [-20...500 Pa], 0...2 in WC [0...500 Pa]
	Overload capability	± 12 in WC [±3000 Pa]
	Altitude compensation	Adaptation to system altitude (adjustable between 0...9800 ft [0 ... 3000 m] above sea level)
	Installation position	Any, no reset necessary
	Materials in contact with medium	Glass, epoxy resin, PA, TPE
	Measuring air conditions	Comfort zone 32...122°F [0...50°C] / 5 ... 95% rH, non-condensing
Safety	Protection class IEC/EN	III Safety extra-low voltage
	Degree of protection IEC / EN	IP54
	EMC	CE according to 2014/30/EU
	Certification IEC/EN	IEC/EN 60730-1 and IEC/EN 60730-2-14
	Rated current voltage	0.8 kV
	Supply / control	
	Control pollution degree	
	Ambient temperature	-22...+122°F [-30...50°C]
	Non-operating temperature	-40...+176°F [-40...80°C]
	Ambient humidity range	95% r.h., non-condensing
	Maintenance	Maintenance-free. Depending on the application, the differential pressure sensor (measuring cross, disc, ...) of the VAV unit is checked occasionally and cleaned if required.
	UL listing	cULus according to UL 60730-1A/-2-14, UL 2043

¹⁾ Set during calibration. Dependent upon VAV box parameters.

VAV – variable operation \dot{V}_{min} \dot{V}_{max}

Wiring diagrams

Example 1:
VAV, analogue reference signal

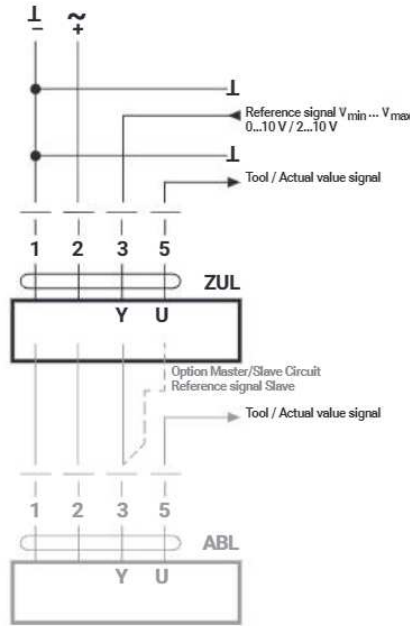

Example 2:
VAV with shut-off (CLOSED), 2...10 V mode

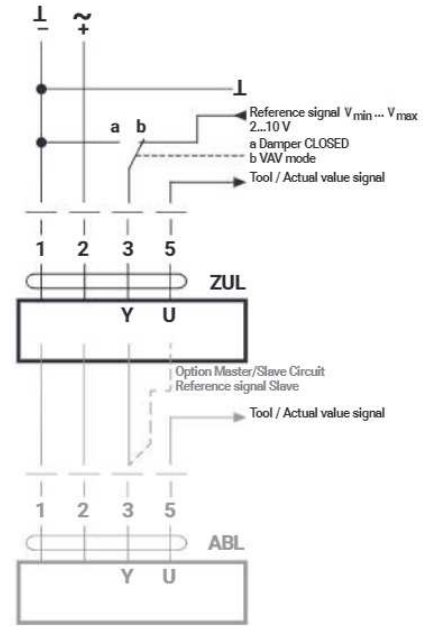

Description:

Damper CLOSED via 0...10 V reference signal (Mode 2...10 V)

Setting parameters:

Mode 2...10 V, Shut off level 0.1 V or 0.5 V

If the required switching threshold of 0.1 V cannot be attained, the value can be switched to 0.5 V with PC-Tool.

Function: Standard 0.1 V: Shut-off level 0.5 V:

Damper		
CLOSED	<0.1 V	<0.5 V
\dot{V}_{min}	>0.1...2 V	>0.5 V...2 V
$\dot{V}_{min} \dots \dot{V}_{max}$	2...10 V	2...10 V

In CAV applications shut-off level must not be set to 0.5 V, otherwise the open connection 3 is interpreted as damper CLOSED.

CAV – step mode CLOSED / \dot{V}_{min} / \dot{V}_{max} / OPEN

CAV control

VAV-Compact can be adapted to the desired CAV function pattern for constant volumetric flow applications with PC-Tool by using the "CAV function":
– Damper CLOSED – \dot{V}_{min} – \dot{V}_{max} – damper OPEN (standard)

Wiring diagrams

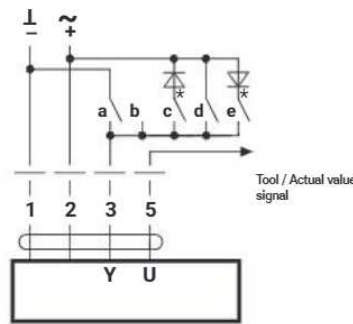

Notes

- Note that the contacts are mutually interlocking.
- DC supply: * c and e are not available with DC 24 V.
- Setting parameters in CAV applications: Mode 2...10 V, Shut-off level 0.1 V
In CAV applications shut-off level must not be set to 0.5 V, otherwise the open connection 3 is interpreted as damper CLOSED.

PC-Tool "CAV Function" setting:
2 ... 10 V, Shut-off level 0.1 V

CAV Function CLOSED – \dot{V}_{min} – \dot{V}_{max} – OPEN (standard)

Signal				
Switching terminal 3				
Mode 2 ... 10 V	CLOSED	\dot{V}_{min}	CLOSED *	\dot{V}_{max}
Mode 0 ... 10 V	\dot{V}_{min}	\dot{V}_{min}	CLOSED *	\dot{V}_{max}

PC-Tool "CAV Function" setting:
CLOSED – \dot{V}_{min} – \dot{V}_{max} . Shut-off level CLOSED: 0.1 V

Control functions - VAV / CAV

VAV-operating volumetric flow – Setting and control

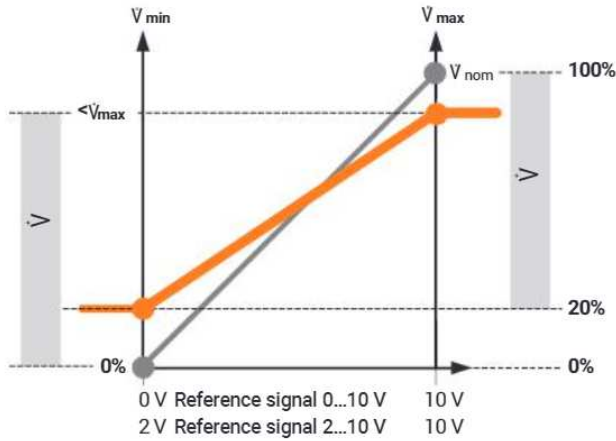

Damper CLOSED via 0...10 V reference signal (Mode 2...10 V)

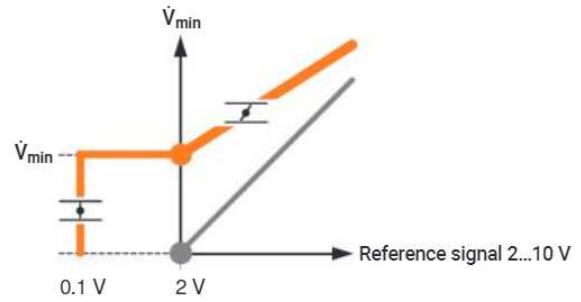

Description:

Setting parameters: Mode 2...10 V, Shut-off level 0.1 V or 0.5 V

If the required switching threshold of 0.1 V cannot be attained, the value can be switched to 0.5 V with PC-Tool.

Function	Standard 0.1 V	Shut-off level 0.5 V
Damper CLOSED	<0.1 V	<0.5 V
\dot{V}_{min}	>0.1...2 V	>0.5 V...2 V
$\dot{V}_{min} \dots \dot{V}_{max}$	2...10 V	2...10 V

In CAV applications shut-off level must not be set to 0.5 V, otherwise the open connection 3 is interpreted as damper CLOSED.

VAV-operating volumetric flow - Example

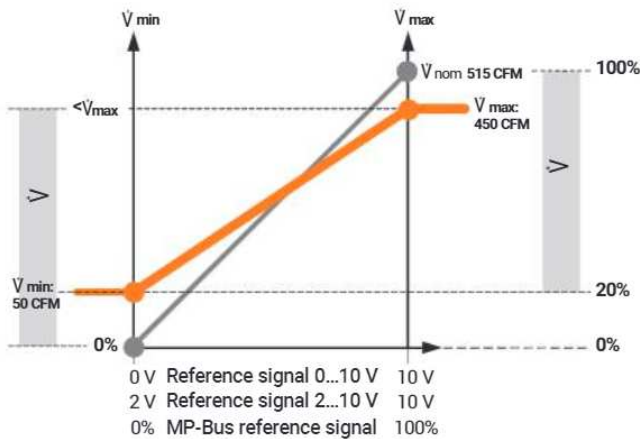

\dot{V}_{nom} - Volumetric flow rate used for calibration

\dot{V}_{max} - Max desired volumetric flow rate

\dot{V}_{min} - Minimum desired volumetric flow rate

CAV operating volumetric flow – setting

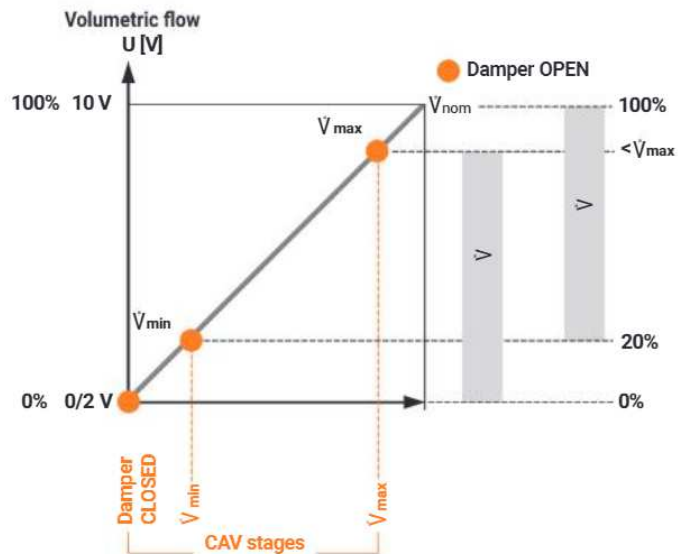

Open-Loop (separate external VAV-Control)

Control damper Y

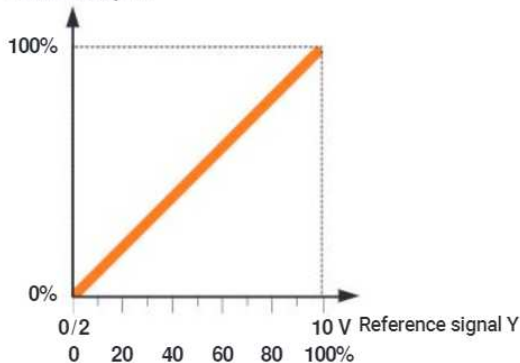

Volumetric flow sensor value

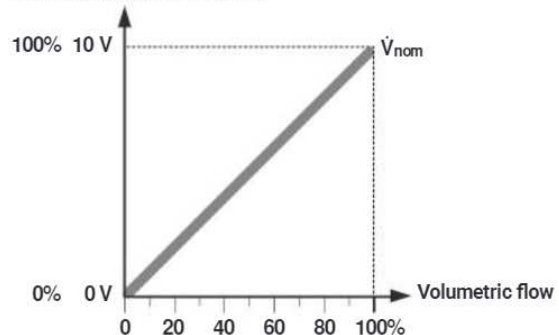

Setting and Tool function

Designation	Adjustment values, limits, explanations	Units			Remarks
			ZTH US	PC-Tool	
System specific data					
Position	16 characters e.g.: Office 4 6.0G ZL	Text	r	r/w	
Designation	16 Characters: Unit designation, etc.	Text	r	r/w	
\dot{V} max	20...100% [\dot{V} nom]	/h / l/s / cfm	r/w	r/w	$\geq \dot{V}$ min
\dot{V} mid	\dot{V} min... \dot{V} max	/h / l/s / cfm	r/w	r/w	
\dot{V} min	0...100% [\dot{V} nom]	/h / l/s / cfm	r/w	r/w	$\leq \dot{V}$ max
System altitude	0...3000 0...9800	Meter Feet	r/w	r/w	Adaptation Δp -Sensor to system altitude (above sea level)
Controller settings					
Controller function	Volumetric flow / open loop			r/w	
Mode	0...10 / 2...10	Volt	r/w 1)	r/w	
CAV function	CLOSED/ \dot{V} min/ \dot{V} max; Shut-off level CLOSED 0.1 V CLOSED/ \dot{V} min/ \dot{V} max; Shut-off level CLOSED 0.5 V			r/w	For an explanation see 2)
Positioning signal Y	Start value: 0.6...30; Stop value: 2.6...32	Volt	r	r/w	
Feedback U	Volume / damper position / Δp			r/w	Definition feedback signal
Feedback U	Start value: 0.0...8.0; Stop value: 2.0...10	Volt		r/w	
Response when switched on (Power-On) 4)	No action / Adaption / Synchronization			r/w	
Synchronization behavior	Y=0 % Y=100 %			r/w	Synchronization to damper position 0 or 100 %
Bus fail position	Last set point / Damper CLOSED \dot{V} min / \dot{V} max / Damper OPEN			r/w	
Unit specific settings *)					
\dot{V} nom	0...35,000 cfm / 0 ... 60,000 m /h	/h / l/s / cfm	r	r/(w*)	Unit specific adjustment value
$\Delta p @ \dot{V}$ nom	0.15...2 in WC [38 ... 500 Pa]	in WC [Pa]	r	r/(w*)	Unit specific adjustment value
Label print function			-	w	Incl. customer logo
Other settings					
Direction of rotation (for Y = 100%)	cw/ccw or ▲/▼		r/w 1)	r/w	
Range of rotation	Adapted ³⁾ / programmed 30...95			r/w	
Torque	100 / 75 / 50 / 25			r/w	% of nominal torque
Renovating Existing systems (Retrofit of old VAV units with leaking damper *) Parameters are only accessible by VAV manufacturers and Retrofit Partners)					
Supress damper leak	Yes/No			r/(w*)	Supresses volume display with the damper closed
Operating data					
Setpoint / actual value Damper position		/h / l/s / cfm Pa / %	r	r	Trend display with print function and data storage on HD
Simulation	Damper CLOSED / OPEN \dot{V} min / \dot{V} mid / \dot{V} max / motor stop				
Running times	Operating time, running time Ratio			r	
Alarm messages	Setting range enlarged, mech. overload, Stop&Go ratio too high			r/w	
Series number	Device ID.		r	r	incl. date of manufacture
Type	Type designation		r	r	
Version display	Firmware, Config table ID		r	r	
Configuration data					
Print, create PDF				Yes	
Save to file				Yes	
Log data / book	Activity log			Yes	incl. complete setting data

Explanations

- 1) Access only on operating level 2
- 2) Shut-off level 0.1 / 0.5V - Application: VAV mode, in Mode 2...10 V, Damper CLOSED via 0...10 V control signal.
If the required switching threshold of 0.1 V cannot be attained, the threshold can be switched to 0.5 V.
Note on CAV application: the shut-off level must not be set to 0.5 V. If the line 3 (Y) is open, damper will be CLOSED instead, min will be activated.
- 3) within the mechanical limit.
- 4) The first time the supply voltage is switched on, i.e. at the time of commissioning, the actuator carries out an adaption, which is when the operating range and position feedback adjust themselves to the mechanical setting range. The actuator then moves into the required position in order to ensure the volumetric flow defined by the positioning signal.
- 5) See www.belimo.us for function and version history.

Display and operation

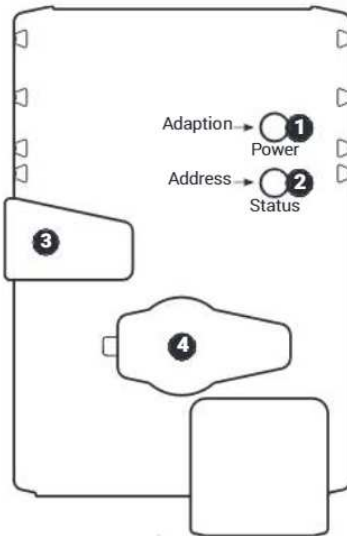

- 1 Push-button and LED display green**
Off: No power supply or fault
On: Operation
Press key: Triggering the angle of rotation adaptation
- 2 Push-button and LED display yellow**
Off: Normal operation
On: Adaptation or synchronizing process active
Press key: Confirmation of the addressing
- 3 Gear disengagement key**
Press key: Gear disengaged, motor stops, manual override possible
Release key: Gear engaged, synchronization starts, followed by standard operation
- 4 Service plug** For connecting the parameterization and service tools

ZTH / PC-Tool - local service connection

The settings and diagnostics of the VAV-Compact can be performed easily and rapidly with the Belimo PC-Tool or with the ZTH-US service tool. When using the PC-Tool, the ZTH US serves as an interface converter.

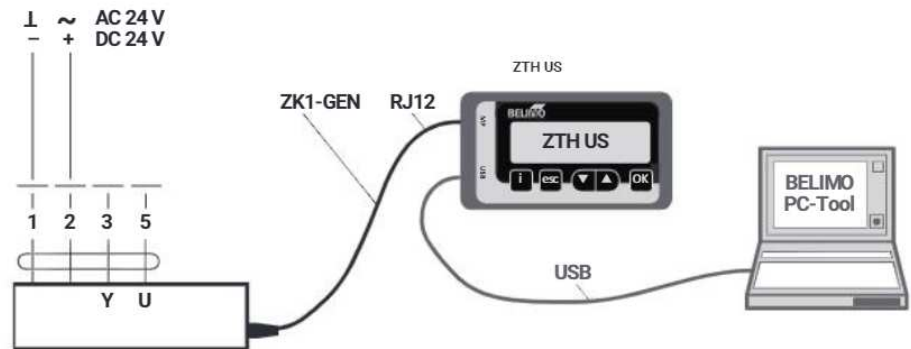

Download PC-Tool (MFT-P) from www.belimo.us

Accessories

Gateways	Description	Type
	Gateway MP to BACnet MS/TP, AC/DC 24 V	UK24BAC
	Gateway MP to Modbus RTU, AC/DC 24 V	UK24MOD
	Gateway MP to KNX/EIB, AC/DC 24 V, EIBA certified	UK24EIB
	Gateway MP to LON ORKS , AC/DC 24 V, LON ARK certified	UK24LON

VAV-Compact	Description
	VAV-Compact: Version with integrated BACnet and Modbus see www.belimo.us for more information and documentation

Electrical accessories	Description	Type
	Connection cable 16 ft [5 m], to ZTH (RJ12) with service plug	ZK1-GEN
	Connection cable 16 ft [5 m], to ZTH (RJ11) with free wire ends	ZK2-GEN

Tools	Description	Type
	Service Tool, for MFT/MP/BACnet/Modbus actuators and VAV controllers	ZTH US
	Belimo PC-Tool, software for adjustments and diagnostics (Free download available at www.belimo.us)	

Dimensions inches [mm]

Dimensional drawings LMV-D3-MFT

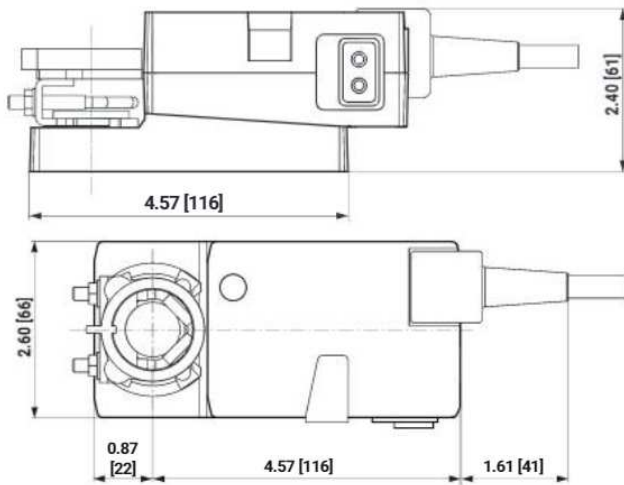

Dimensional drawings NMV-D3-MFT

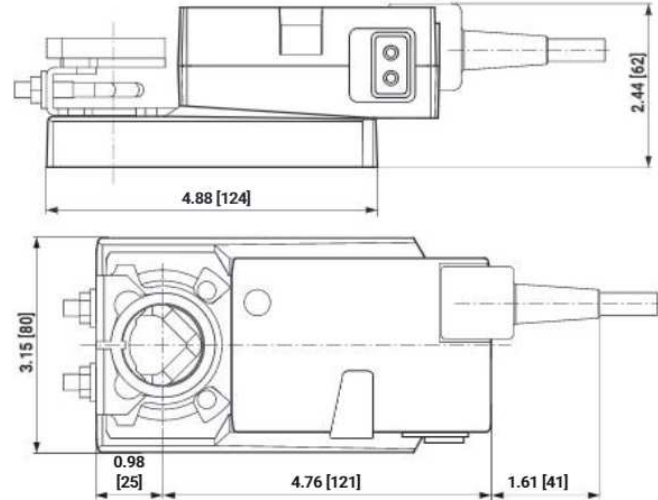

FCC notes (relevant only for US market)

This device complies with part 15 of the FCC:

Operation is subject to the following two conditions:

1. This device may not cause harmful interference, and
2. this device must accept any interference received, including interference that may cause undesired operation.

The following statement applies to the products covered in this manual, unless otherwise specified herein. The statement for other products will appear in the accompanying documentation.

NOTE:



This equipment has been tested and found to comply with the limits for a Class B digital device, pursuant to part 15 of the FCC Rules. These limits are designed to provide reasonable protection against harmful interference in a residential installation. This equipment generates, uses and can radiate radio frequency energy and, if not installed and used in accordance with the instructions, may cause harmful interference to radio communications. However, there is no guarantee that interference will not occur in a particular installation.

If this equipment does cause harmful interference to radio or television reception, which can be determined by turning the equipment off and on, the user is encouraged to try to correct the interference by one or more of the following measures:

- Reorient or relocate the receiving antenna.
- Increase the separation between the equipment and receiver.
- Connect the equipment into an outlet on a circuit different from that to which the receiver is connected.
- Consult the dealer or an experienced radio / T.V. technician for help.

Further documentation

- Tool connections

	-MFT	-MP	-MOD
			
Field of application: Supply and exhaust air in the comfort zone and sensor-compatible media			
AC/DC 24 V supply			
Integrated Δp sensor, dynamic D3, measuring range:	-0.08...2 in WC [-20...500 Pa]	-0.08...2 in WC [-20...500 Pa]	-0.08...2 in WC [-20...500 Pa]
Actuator variants:			
– Rotary actuator	45/90 in-lb [5/10 Nm]	45/90 in-lb [5/10 Nm]	45/90 in-lb [5/10 Nm]
– Linear actuator		100/200/300 mm	
VAV function \dot{V}_{\min} ... \dot{V}_{\max}			
CAV stages \dot{V}_{\min} / \dot{V}_{mid} / \dot{V}_{\max}			
Open Loop (external V control)			
DCV	Yes*	DDC MP Partners*	Yes*
Analog control	0/2...10 V	0/2...10 V	0/2...10 V
With Bus control			
Bus specification		Belimo MP Bus	Modbus RTU / BACnet MS/TP / RS485
Direct integration DDC MP Partners			
Integration via Gateway			
– BACnet			
– KNX			
– LONWORKS®			
– Modbus RTU			
Number of bus devices		8 per strand	32 per strand
Sensor integration			
– passive (resistance)			
– active (0...10 V)			
– Switching contact			
Optional control function			
Local forced (override)		CLOSED / \dot{V}_{\max} / OPEN	CLOSED / \dot{V}_{\max} / OPEN
Aids		MP-Bus Tester MP Monitor	
Integration tools		PC-Tool	
TypeList function (Retrofit, OEM)			(-)
Tool connection (U – PP/MP)	PP	PP/MP	PP
Service socket ZTH / PC-Tool			
NFC interface			
Assistant App			
Service tool ZTH US			
PC-Tool			
– Parameter			
– Save data			
– Trend, Logbook			
– Label Print			

* Third party controller or control logic within BMS required.

