

SPECIFICATIONS

Valve

Service Hot and chilled water models, up to 50% glycol. Steam models up to 15 psi (both valve body and valve actuator must be rated for high temperature).

System Static Pressure Limits 400 psi (2758 kPa).

Close-off Refer to Table-2.

Fluid/Ambient Temperature Limits Refer to Table-1.

Seat Leakage ANSI class IV (0.01%) with pressure at inlet (B-port/A-port, if 3-way).

Body Forged brass.

Stem Nickel-plated.

Seat Brass.

Paddle (VT series) Buna N.

Paddle (VS series) Highly saturated nitrile.

Actuator

Voltage 24 Vac @ 50/60 Hz, 110 Vac @ 50 Hz and 120 Vac @ 60 Hz, 230 Vac @ 50 Hz, 240 Vac @ 60 Hz, 208 Vac @ 50/60 Hz., 277 Vac @ 50/60 Hz.

Power Requirements 6.5 watts, 7.5 Va.

End Switch, 24 -240 Vac Models: 24 to 250 Vac/101 mA min. to 5 A max. and 9 to 30 Vdc @ 100 mA max. **277 Vac Models:** 277 Vac/101mA min. to 5A max.

Control Signal On/off, 2 position, spring return.

Timing, Full Open to Full Close 25 Sec max for 60 Hz; 30 Sec max for 50 Hz; and 9 Sec max spring return.

Materials Stainless steel base plate, aluminum cover.

Ambient Temperature Limits:

Shipping & Storage -40 to 160 °F (-40 to 71 °C).

Operating Refer to Table-1.

Humidity 5 to 95% relative humidity, non-condensing.

Agency Listings Refer to your individual product label.

Shipping Weight (Actuator/Valve Assembly) 2.25 lbs (1020 g).

Table-1 Valve Body and Actuators Model Chart

Model	Temperature Range
VTXXXX	32 to 200 °F (fluid) @ 104 °F (Ambient) (0 to 93 °C @ 40 °C)
VSXXXX	32 to 250 °F (fluid) @ 169 °F (Ambient) (0 to 121 °C @ 76 °C), and/or 15 PSI (103 kPa) Steam
AXX3XXX	32 to 200 °F (fluid) @ 104 °F (Ambient) (0 to 93 °C @ 40 °C)
AXX4XXX	32 to 250 °F (fluid) @ 169 °F (Ambient) (0 to 121 °C @ 76 °C), and/or 15 PSI (103 kPa) Steam

a: For steam applications both valve body and valve actuator must be rated for high temperature. Example: VS2213G14A020 = Assembly, VS2213 = Valve body, AG14A020 = Actuator.

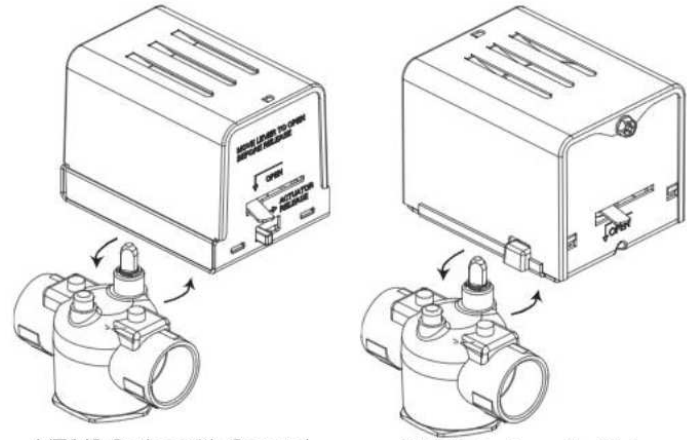

VT/VS Series with General Close-Off Actuator

VT/VS Series with High Close-Off Actuator

Table-2 Flow Coefficients and Maximum Close-Off Pressure Differential

Valve Size	2-way Cv (kv)	3-way Cv (kv)	(G) ^a Close-Off DP PSI (kPa)	(H) ^b PSI Close-Off DP (kPa)
1/2"	1.0 (0.9)	1.5 (30)	60 (414)	75 (517)
3/4"				
1/2"	2.5 (2.2)	3.0 (2.6)	40 (276)	50 (344)
3/4"				
1/2"	3.5 (3.0)	4.0 (3.4)	25 (172)	30 (208)
3/4"				
1"	5.0 (4.3)	5.0 (4.3)	20 (137)	25 (172)
3/4"				
1"	7.5 (6.5)	7.5 (6.5)	17 (117)	20 (137)
3/4"				
1"	8.0 (6.9)	8.0 (6.9)	17 (117)	20 (137)
1-1/4"				

^a G = General close off actuator
^b H = High close off actuator

Accessories for Inverted Flare Connection Valves

3/4" inverted flare bodies accept the following adapters to copper pipe:

436-214-1 Union nut & elbow assembly, female for 1/2" (5/8" O.D.) copper, 15/16" long

436-220 Union nut & coupling assembly, female for 1/2" (5/8" O.D.) copper, 1-1/16" long

436-252 Union nut & coupling assembly, female for 3/4" (7/8" O.D.) copper, 1-27/32" long

436-229-3 Union nut & nipple assembly, male for 1/2" (5/8" O.D.) copper, 3" long

436-214-4 Union nut & elbow assembly, male for 1/2" (5/8" O.D.) copper, 1-15/16" long

436-256 Union nut & coupling assembly, female for 1" (1-1/8" O.D.) copper, 1-3/8" long

TYPICAL APPLICATION (wiring diagram)

Honeywell - Wire Leads

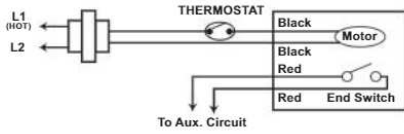

Honeywell - Terminal Block

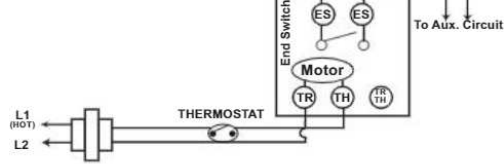

Erie Wire Leads

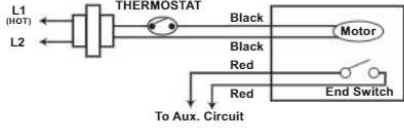

Erie Terminal Block

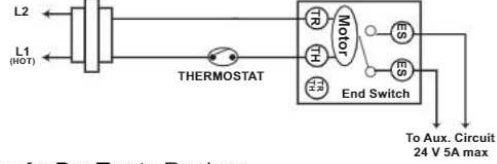
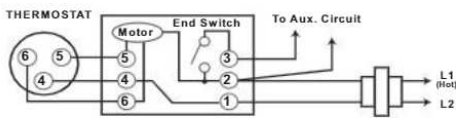
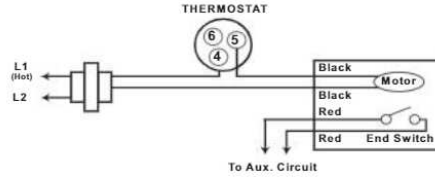

Figure-1 Typical Wiring of a PopTop to Replace a Honeywell Valve.

White - Rodgers (1311 or 1321)



Erie Wire Leads



Erie Terminal Block

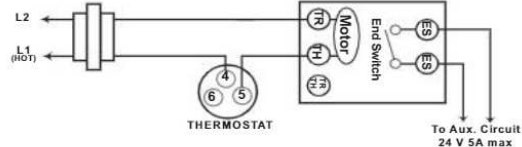
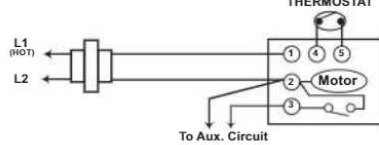
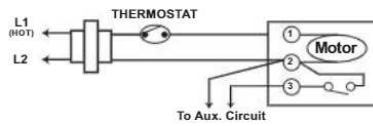

Figure-2 Typical Wiring of a PopTop to Replace a Flair or White-Rodgers 3-Wire Valve.

Flair - Terminal Block



Taco - Terminal Block



Erie Wire Leads

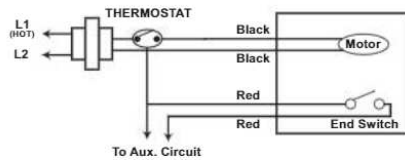

Erie Wire Leads

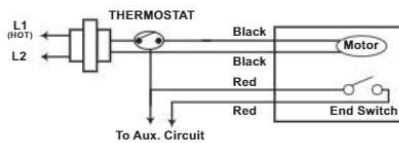

Erie Terminal Block

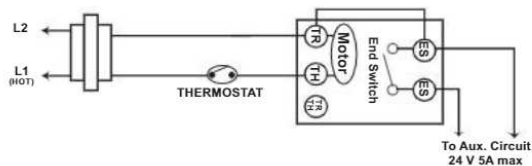

Figure-3 Typical Wiring of a PopTop to Replace a Flair or Taco 3-Wire Valve.

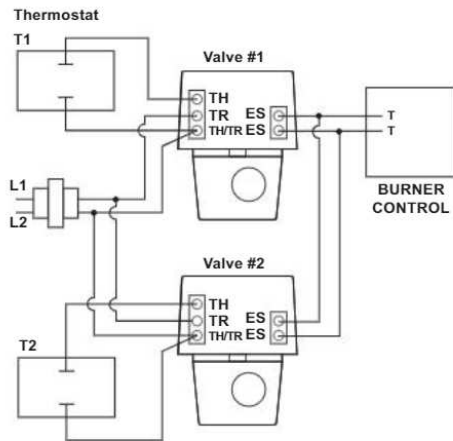

Figure-4 Typical Multiple Valve Wiring.

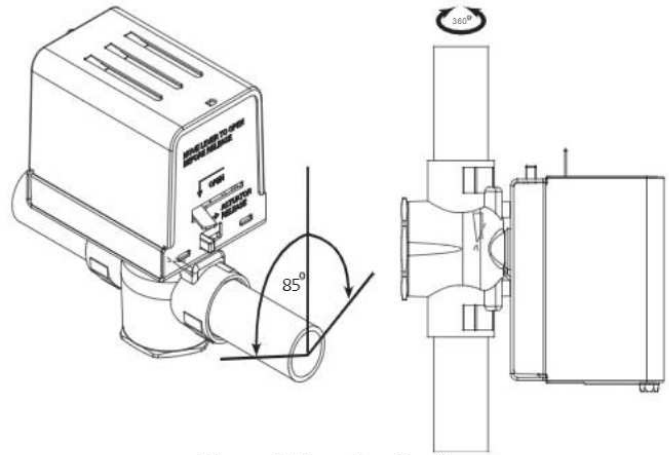

Figure-5 Mounting Position.

INSTALLATION

Inspection

Inspect the package for damage. If package is damaged, notify the appropriate carrier immediately. If undamaged, open the package and inspect the device for obvious damage. Return damaged products.

Requirements

- Tools (not provided)
 - Wrench 1 to 1-5/8" (if threaded valve)
 - Soldering equipment (if sweat fit) or flare
- Training: Installer must be a qualified, experienced technician
- Other accessories as appropriate

Precautions

General

▼ WARNING

- Electrical shock hazard! Disconnect power before installation to prevent electrical shock or equipment damage.
- Make all connections in accordance with the electrical wiring diagram and in accordance with national and local electrical codes. *Use copper conductors only.*
- All conductors shall be provided with insulation rated for the highest voltage motor and end switch circuits.

▼ CAUTION

- Avoid locations where excessive moisture, corrosive fumes, explosive vapors, or vibration are present.
- Avoid electrical noise interference. Do not install near large conductors, electrical machinery, or welding equipment.
- When making lead connections within the actuator, use caution not to put leads or connectors below the motor.

Mounting

The valves can be mounted in horizontal or vertical piping. When installed in horizontal piping, the actuator must be above the valve body. Refer to Figure-5. When installed in horizontal piping the actuator can be tilted left or right but it must not be tilted below 85° from vertical.

NOTE

- Make certain there is no overhead water source that may drip onto valve actuator.
- In normal service, some condensation may occur on or around the valve. A drip pan may be necessary or the valve body may be insulated.

Piping

These valves must be piped so the paddle closes against the direction of flow. Flow is from B to A. Refer to Figure-6a to Figure-6f. When installing the actuator to a normally closed valve, the actuator must be placed in the manually open position by using the manual operating lever. The first time the valve is operated electrically, the manual operating lever of the actuator will transfer to the automatic position. The manual operating lever can be used to allow flushing of the system after installation. The valves are designed for application in closed hydronic heating and cooling systems. High levels of dissolved oxygen and chlorine found in open systems may attack the valve materials and result in premature failure. Install over a drip pan if condensation in chilled water applications occurs.

▼ CAUTION

Use in systems which have substantial make-up water (open systems) is not recommended. Follow proper water treatment practices and system procedures. Refer to document F-26080-1 for Water and Steam EN205 Guidelines.

NOTE

- Three-way valves always require a normally closed actuator.
- Three-way valves are always closed at the B port when no power is applied to the motor.
- On power-up the valve closes to A port on three-way valves.
- Orient the three-way valve body as needed for normally open or normally closed flow through coil.

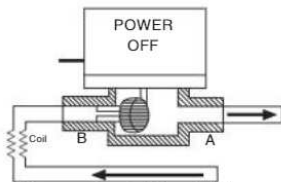

Figure-6a 2-Way Valve With Normally Closed Actuator.

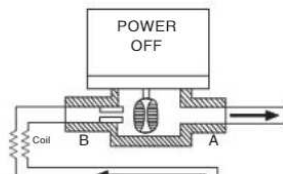

Figure-6b 2-Way Valve With Normally Open Actuator.

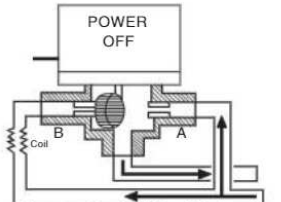

Figure-6c 3-Way Valve in Mixing Configuration Normally Closed to the Coil.

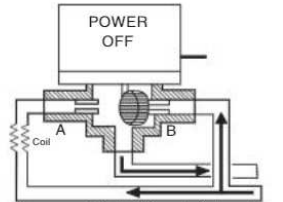

Figure-6d 3-Way Valve in Mixing Configuration Normally Open to the Coil.

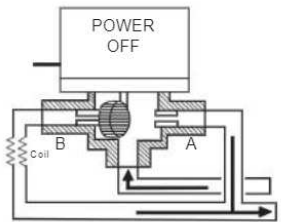

Figure-6e 3-Way Valve in Diverting Configuration Normally Closed to the Coil.

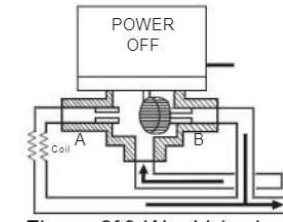

Figure-6f 3-Way Valve in Diverting Configuration Normally Open to the Coil.

Sweat Connections

▼ CAUTION

Do not solder with actuator in place, or with paddle against seat, as the heat can damage the unit. Before soldering, move the manual open lever into Open position then remove the actuator from the body. Orient paddle so it is not against a seat.

Use lead or tin based solder with melting point below 600 °F. Do not overheat. Direct flame tip away from valve. Cool valve quickly with a wet cloth.

Body assembly can be submerged for leak testing prior to attaching the actuator.

Threaded Connection

Apply Teflon tape to all but the last two threads of male pipe thread. Hand screw the pipe into the valve, turning it as far as it will go. Use a wrench to fully tighten the valve to the pipe. Do not over tighten or strip the threads.

Inverted Flare Union Connection

Solder fittings onto pipe. Use solder with melting point below 600°F. Mount valve to union nuts.

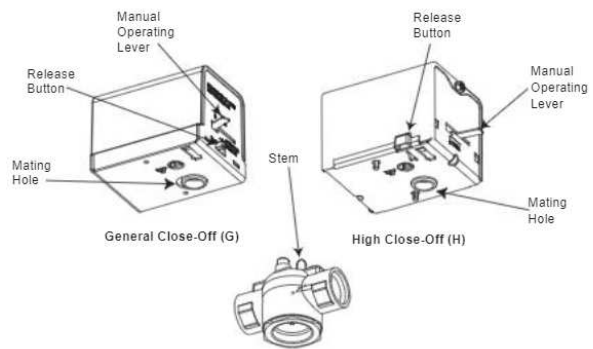

Figure-7 PopTop Installation.

Installing Actuator on Valve Body

Slowly latch the manual operating lever in the open, engaged position (AG1 or AH1 only). Depress the release button (see Figure-7). Align the body with the actuator to ensure the stem is inserted into the large mating hole on the bottom side of the actuator. Engage the actuator on the body and release the button.

▼ CAUTION

Do not use the valve body to manually open the actuator as damage to the valve actuator will result.

CHECKOUT

1. Make sure the valve stem rotates freely before and after installing the actuator.
2. If the stem does not operate freely it may indicate that the stem was damaged and may require that the valve be repaired or replaced.
3. After the piping is under pressure, check the valve body and the connections for leaks.
4. After the valve and actuator are installed, power the actuator and check the operation.

THEORY OF OPERATION

PopTop Series are two position spring return valves. When powered, the actuator moves to the desired position, tensing the spring return system. When power is removed the actuator returns to the normal position.

PopTop Series two position spring return valves can be purchased with an optional built-in auxiliary SPDT end switch for interfacing or signaling; for example, zone pump burner control.

MAINTENANCE

PopTop Series two position spring return valves are maintenance free. Replace defective modules. Actuator may be replaced without removing the valve.

Regular maintenance of the total system is recommended to assure sustained, optimum performance.

FIELD REPAIR

Replace any damaged or failed components with complete replacement unit.